

ENG

G-Kaiser sliding wardrobe

UA

G-Кайзер розсувна шафа

2400x2000x600 mm

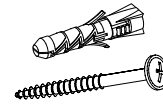
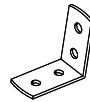
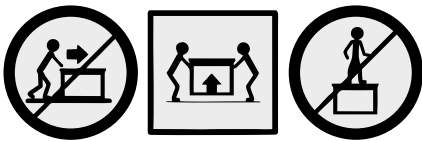
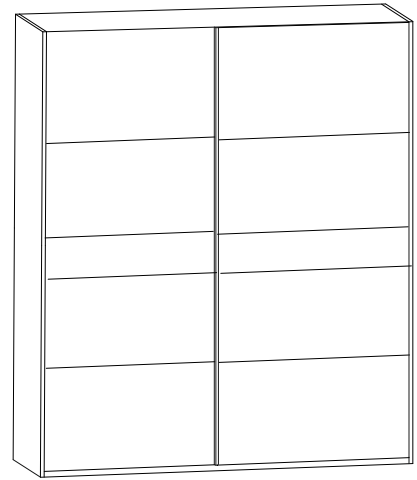
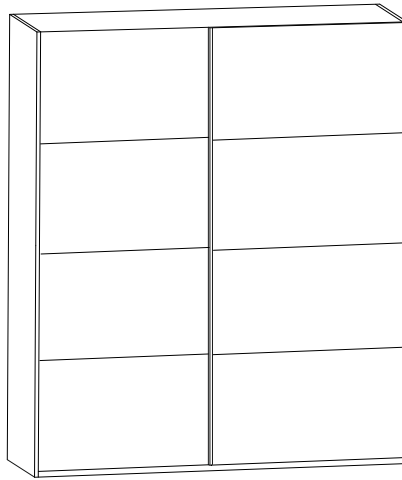
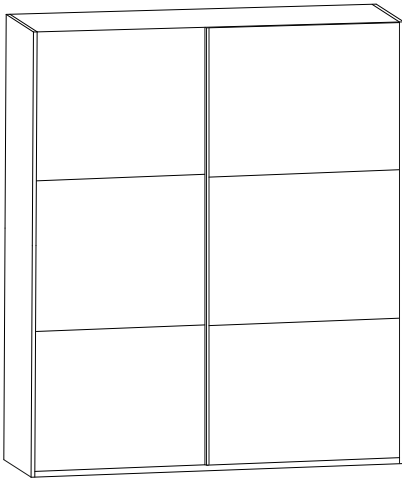
**To avoid falling**

we recommend fixing the product to the wall using **corners** or **double-sided tape**

Purchase separately.

ENG

**Щоб уникнути падіння виробу**

рекомендуємо закріпити його до стіни **кутиками** чи **двосторонньою стрічкою**.

Необхідно придбати окремо.

UA

ENG



UA

**RULES FOR USE AND CARE OF FURNITURE**

1. Use furniture only in dry rooms protected from the effects of weather conditions.
2. Install with suitable tools according to these assembly instructions.
3. Try to assemble as close to the location as possible.
4. The body is assembling in a horizontal position.
5. Before moving furniture, make sure that it is not loaded with items.

**Caution:** moving furniture may damage it.

When moving, hold on to vertical elements only; moving furniture by horizontal parts can break the product.

6. Overloading the furniture can damage it.
7. From time to time check the fittings and their correct position.
8. Wipe the furniture surface only with a slightly damp cloth or paper towels. Do not use chemical cleaning agents other than those specifically made for this.

**ПРАВИЛА ВИКОРИСТАННЯ ТА ДОГЛЯДУ ЗА МЕБЛЯМИ**

1. Використовуйте меблі тільки в сухих приміщеннях, захищених від впливу погодних умов.
2. Виконуйте установку за допомогою відповідних інструментів відповідно до даної інструкції зі складання.
3. Намагайтеся проводити збірку якомога ближче до місця використання.
4. Збірка корпусу здійснюється в горизонтальному положенні.
5. Перед переміщенням меблів переконайтеся, що вони не навантажені.

**Увага:** переміщення меблів може привести до її пошкодження.

При переміщенні тримайтеся тільки за вертикальні елементи, переміщаючи меблі за горизонтальні деталі ви можете зламати виріб.

6. Перевантаження меблів може привести до їх пошкодження.
7. Час від часу перевіряйте кріплення і правильність їх положення.
8. Протирайте поверхню меблів тільки добре віджатою вологою тканиною або ж паперовими рушниками. Не використовуйте хімічні засоби для очищення, крім спеціально для цього призначених.

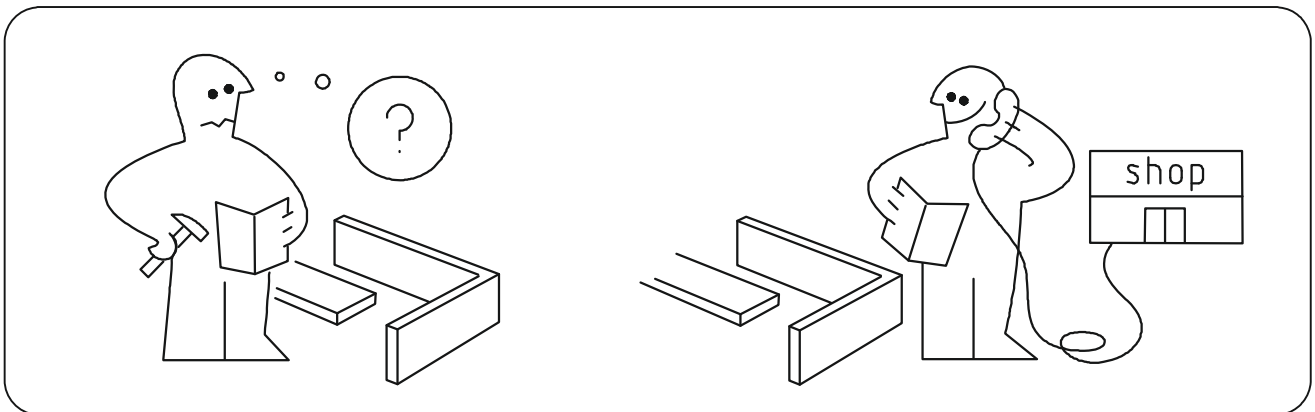
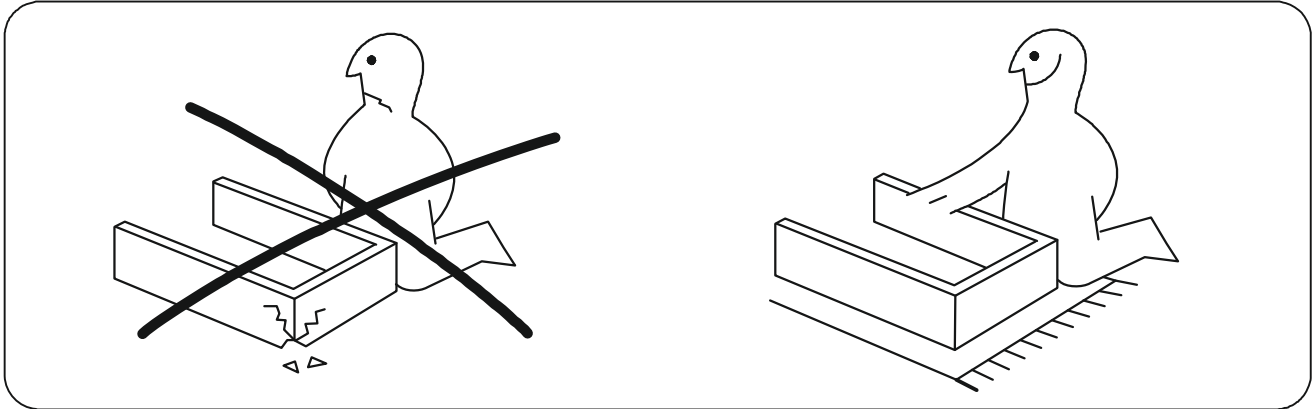
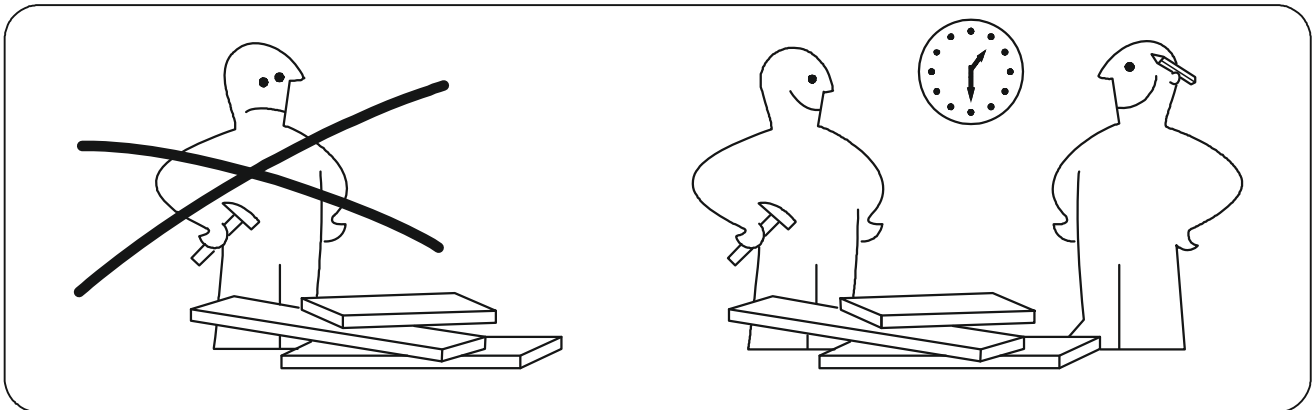
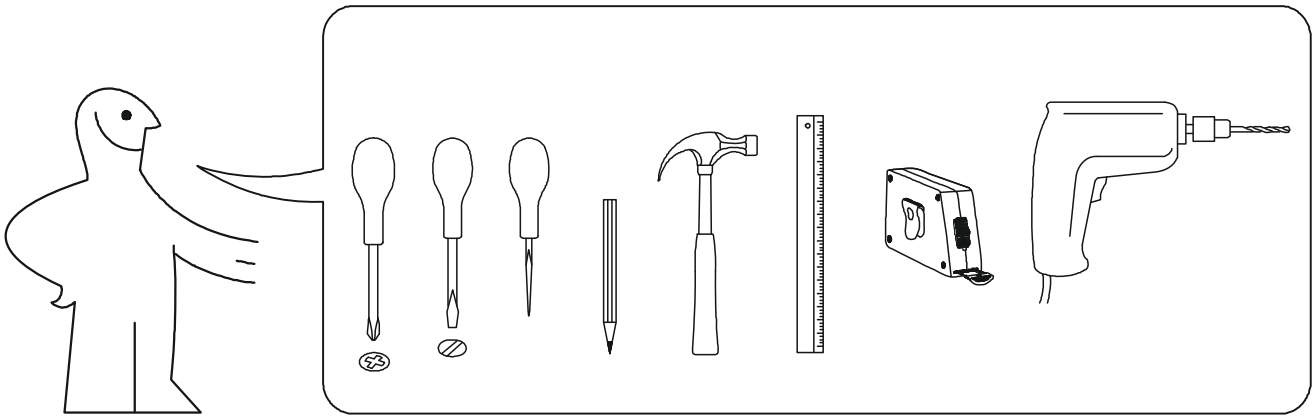

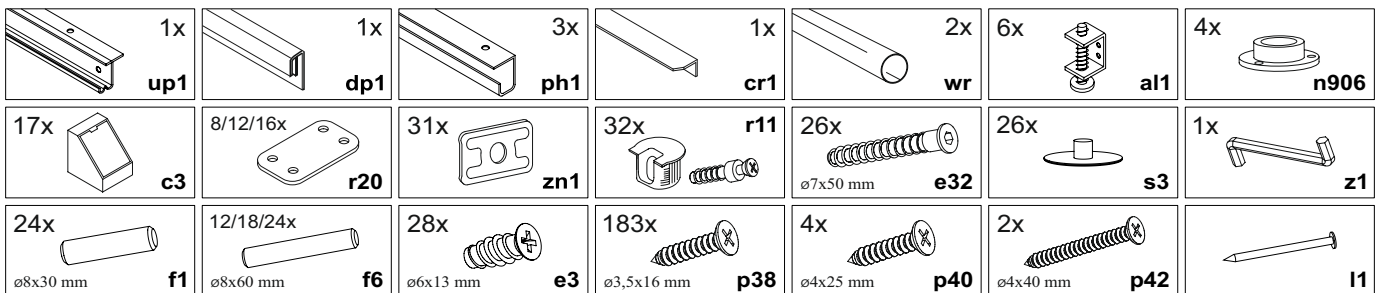
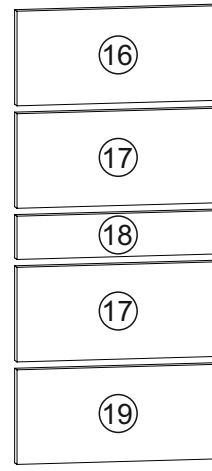
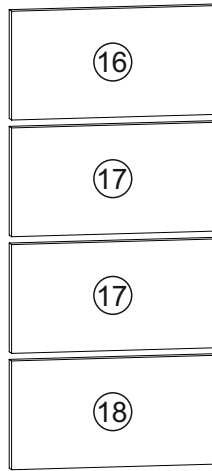
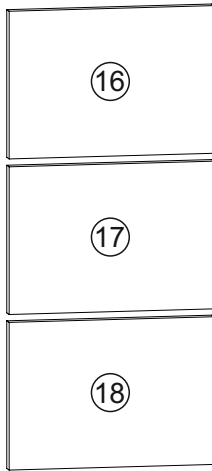
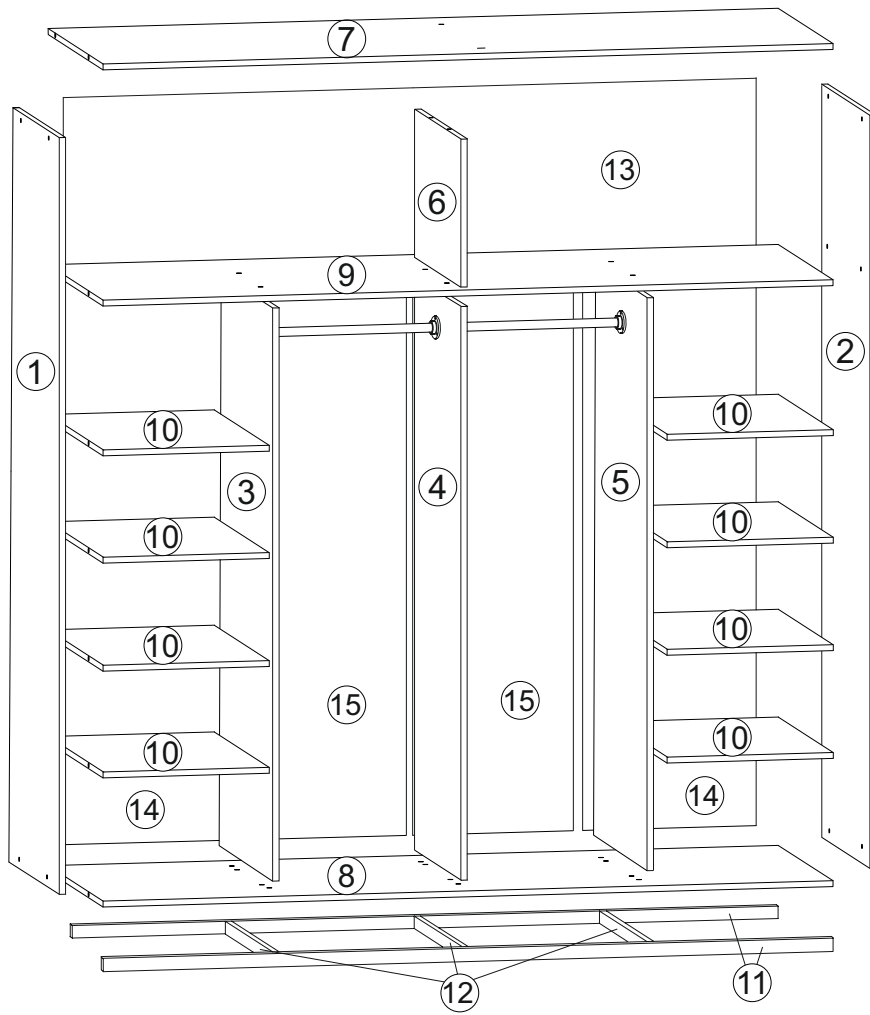

1

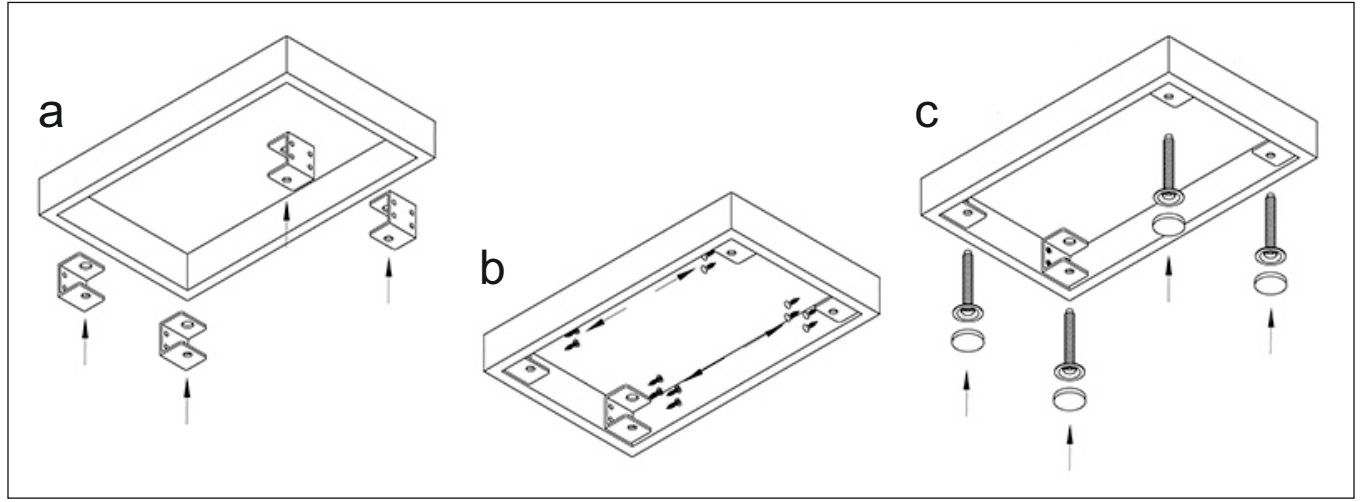
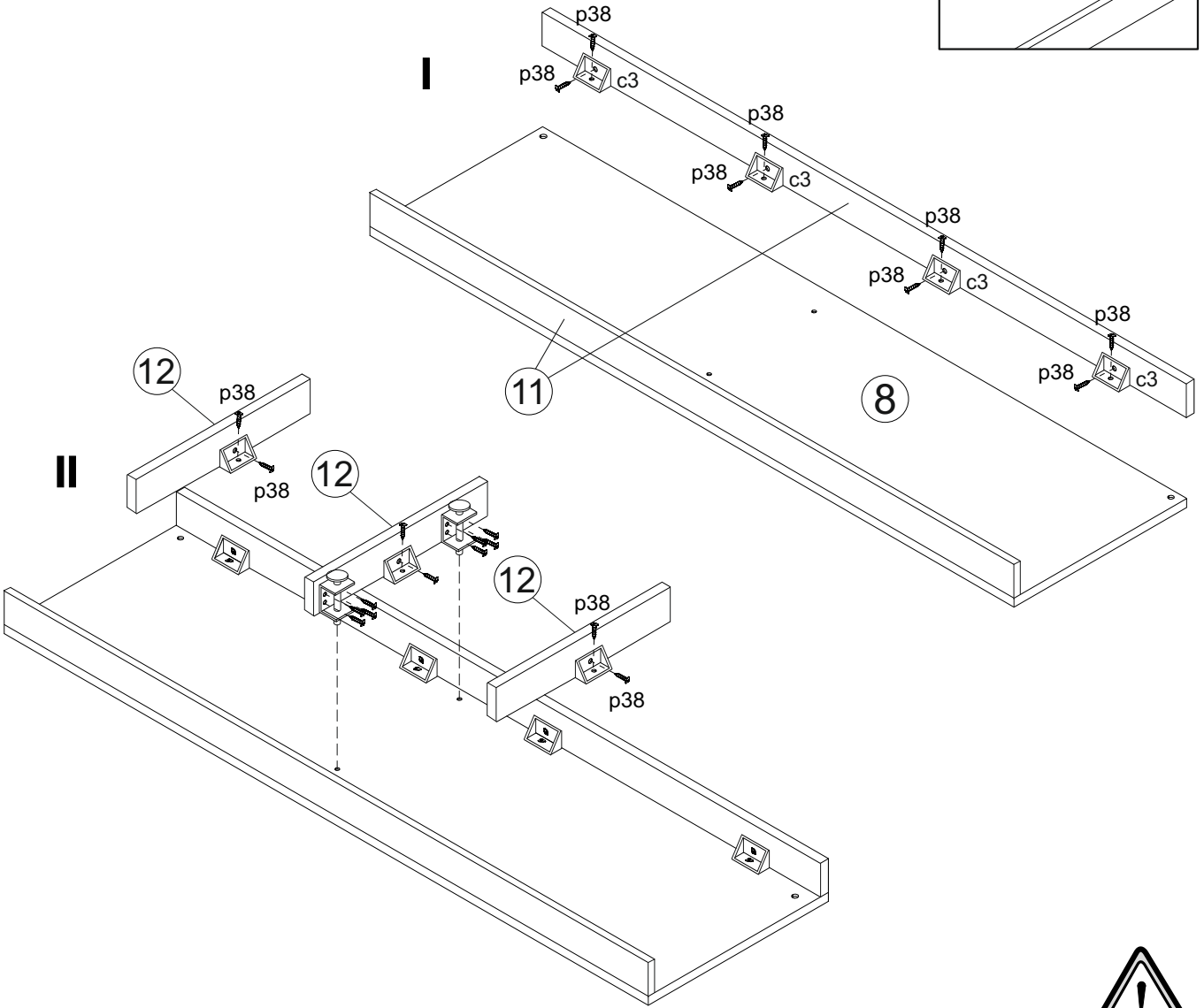
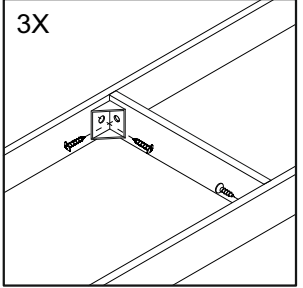
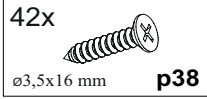
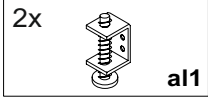
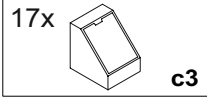

# 2

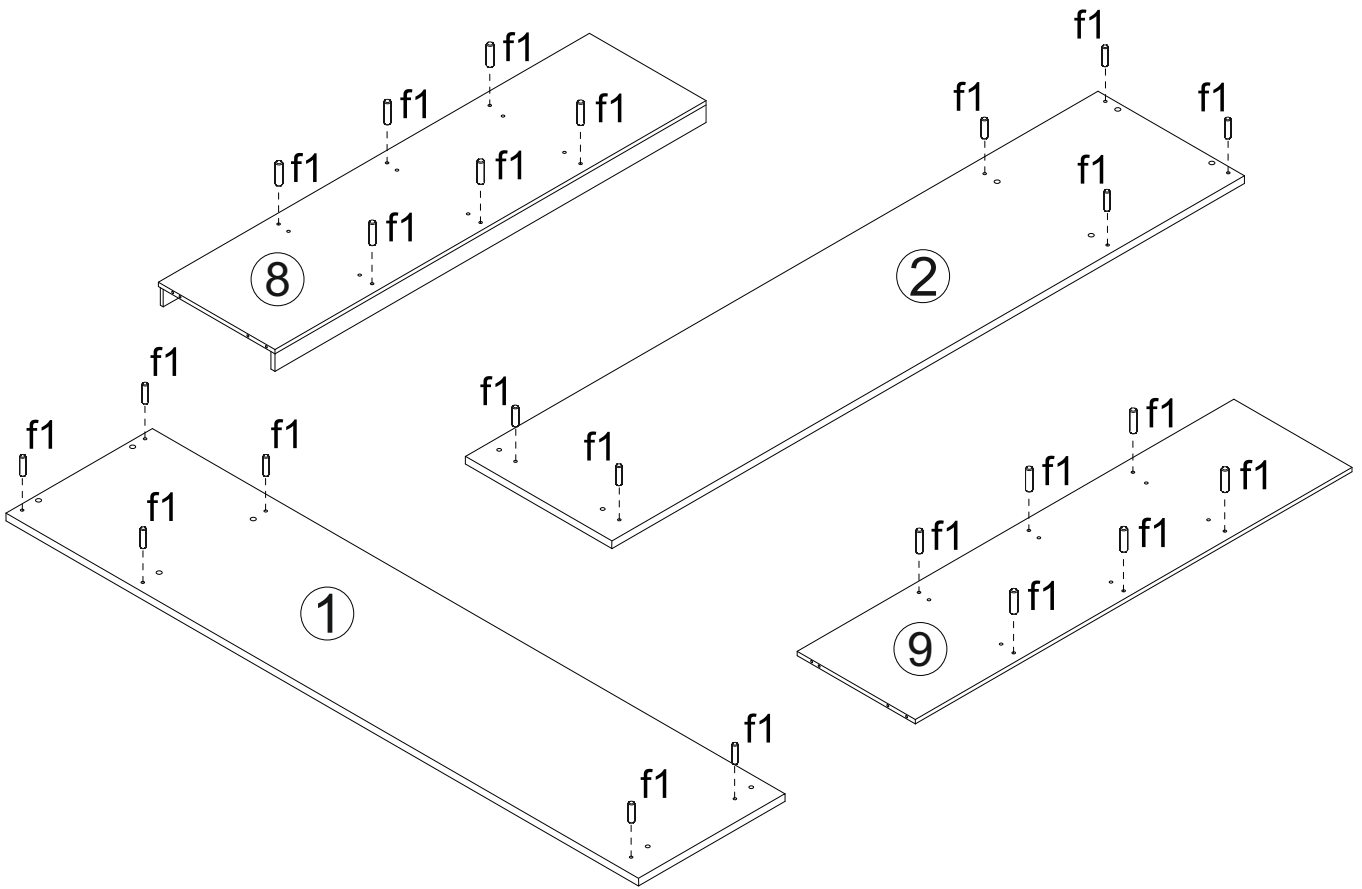
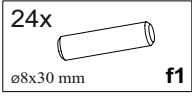

# 3

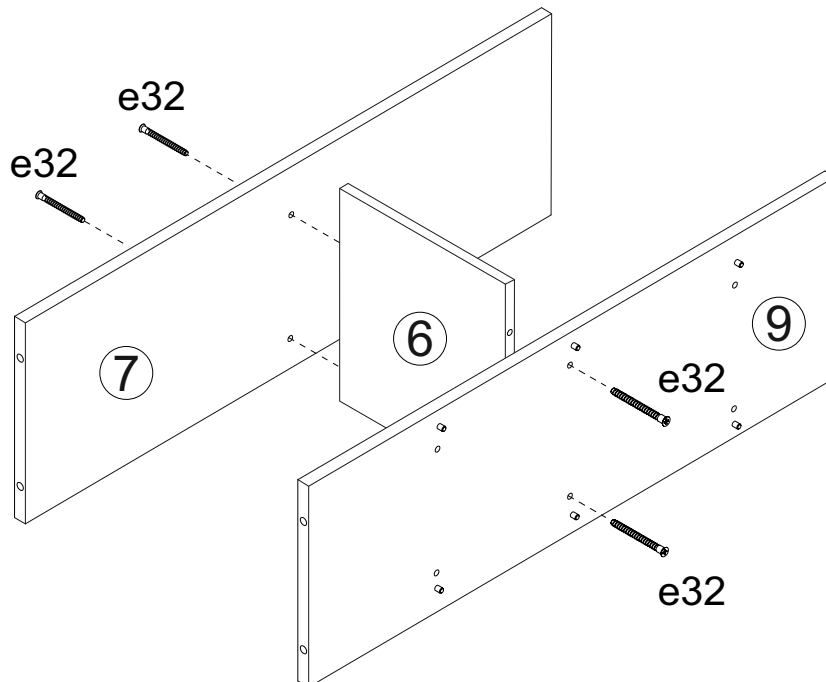
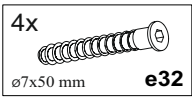

4

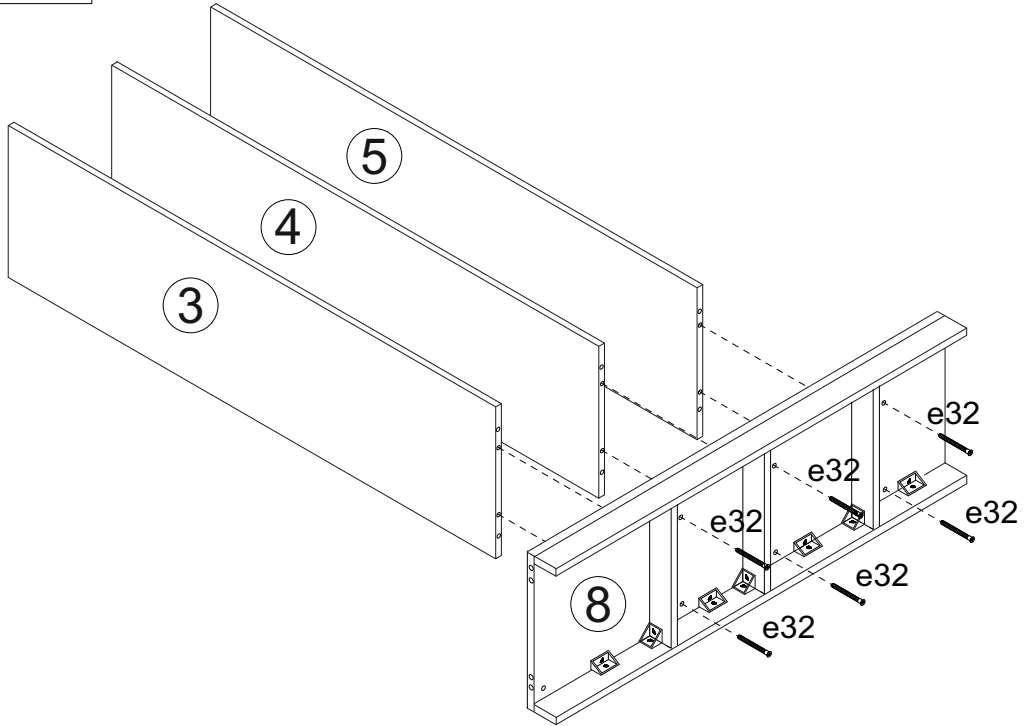
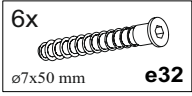

5

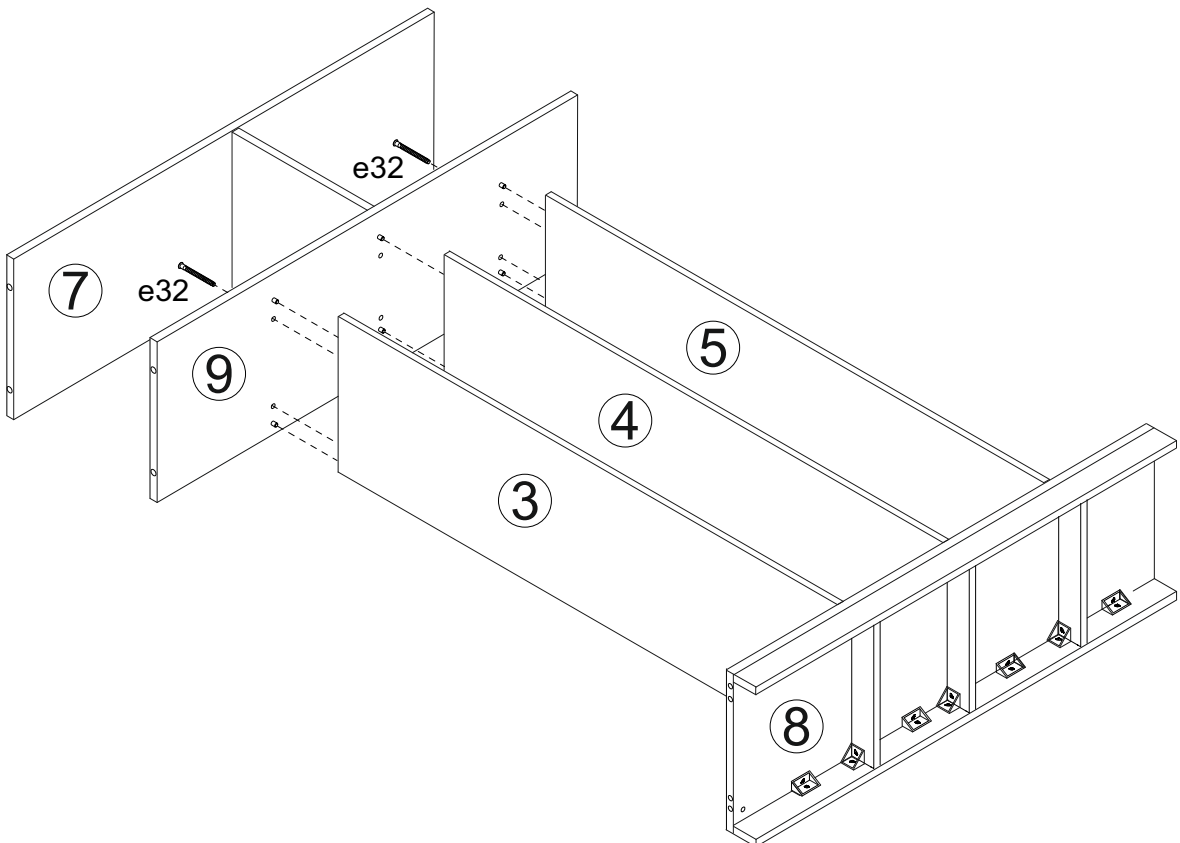
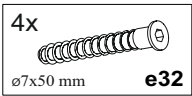

# 6

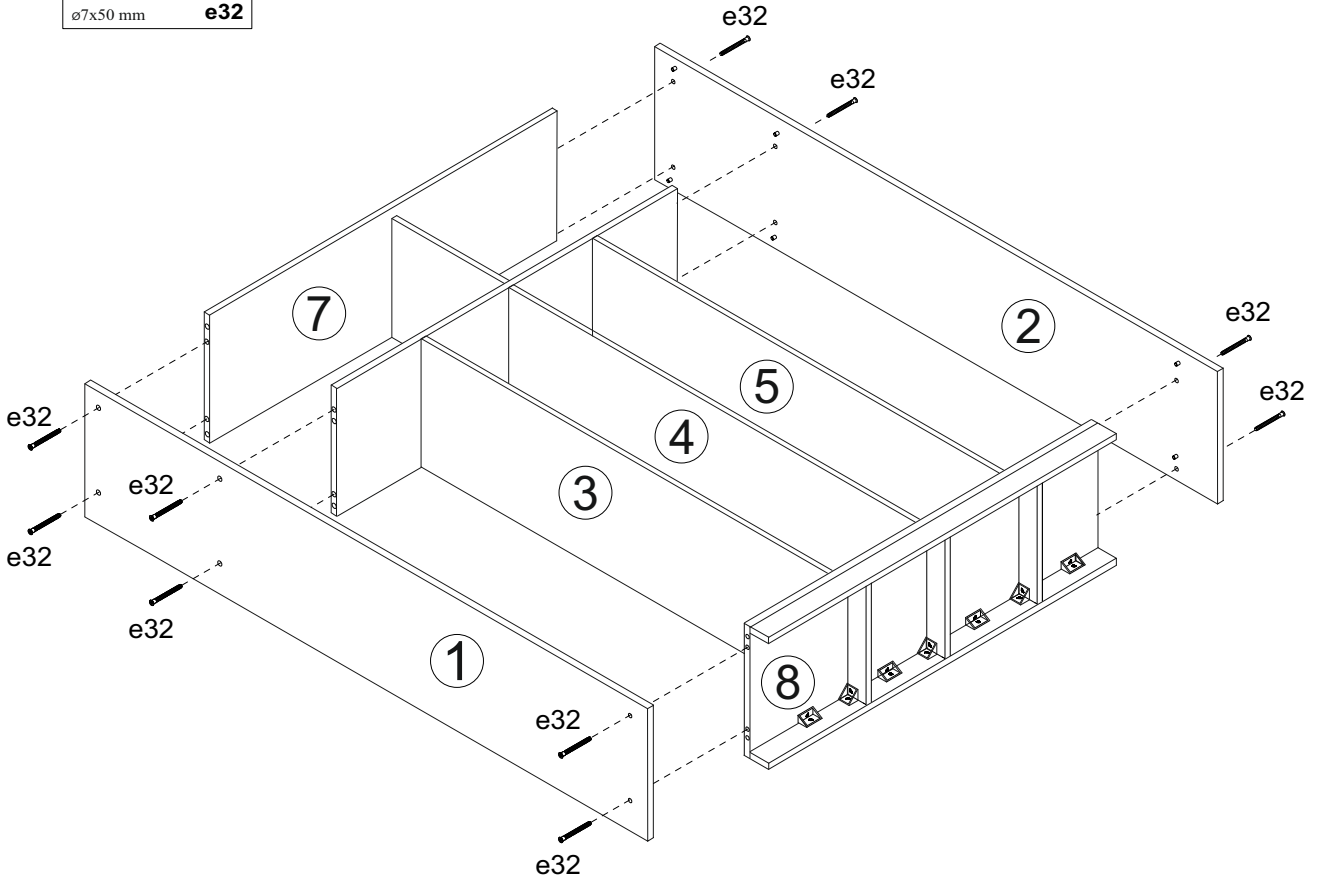
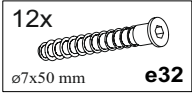

# 7

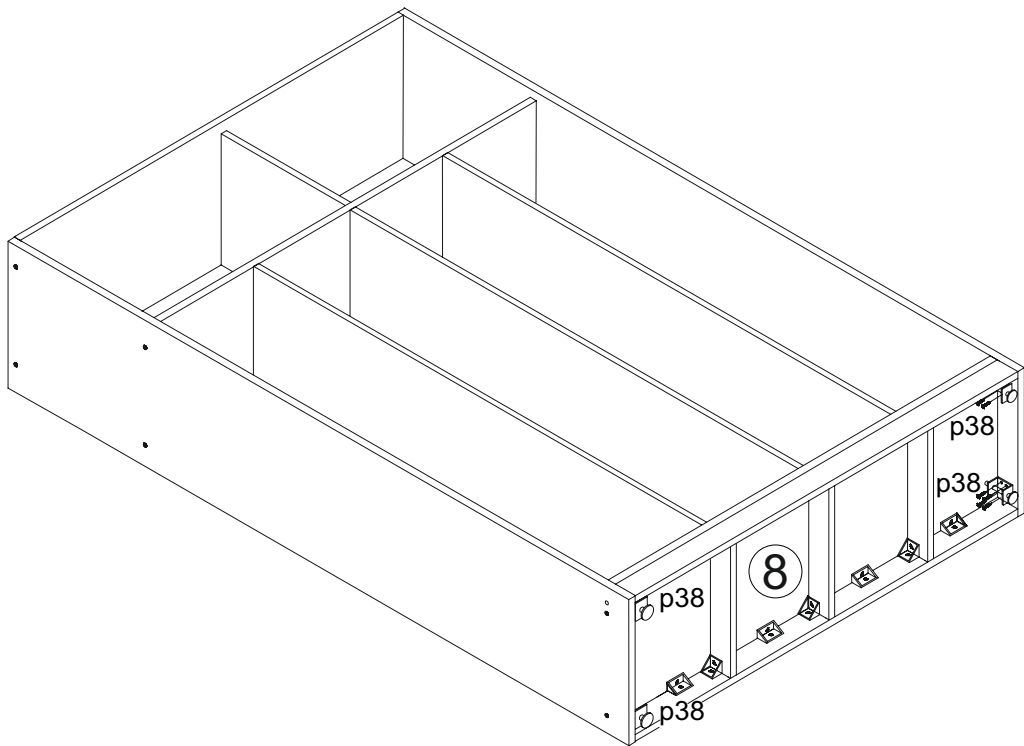
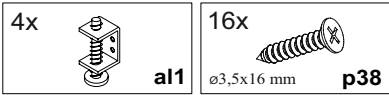

# 8

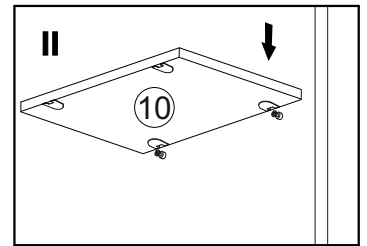
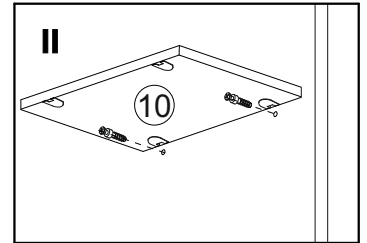
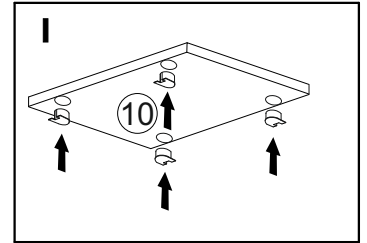
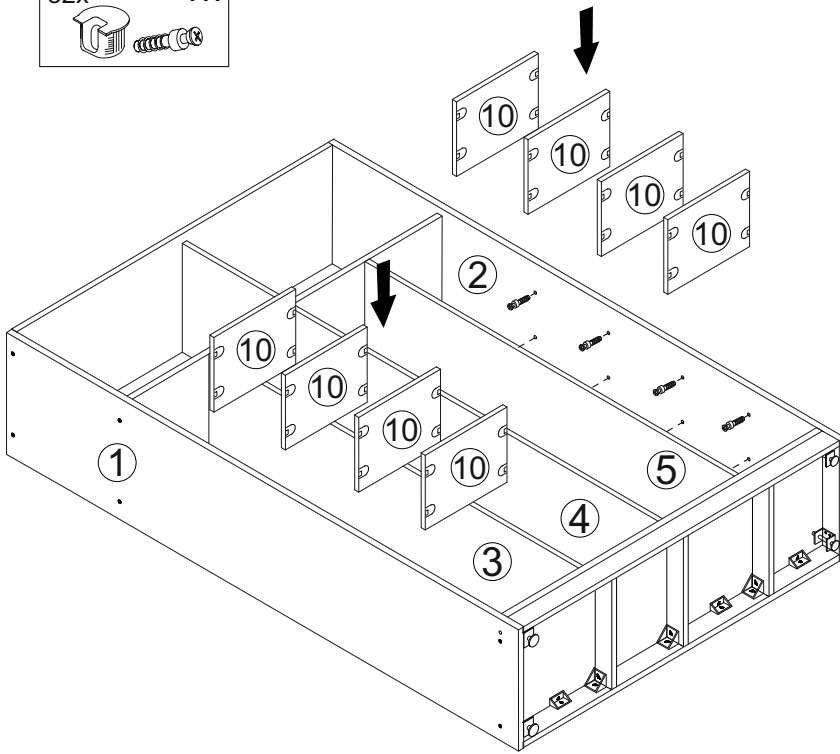
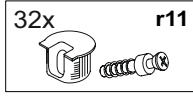

# 9

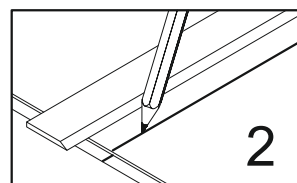
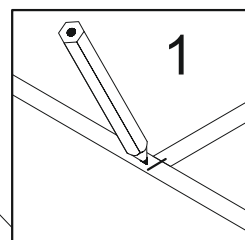
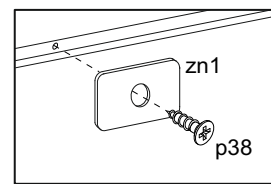
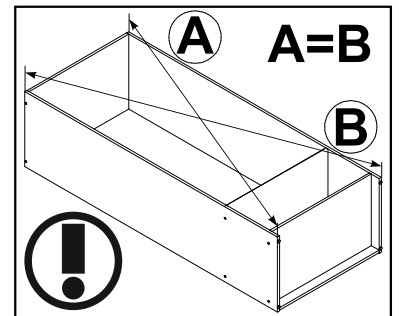
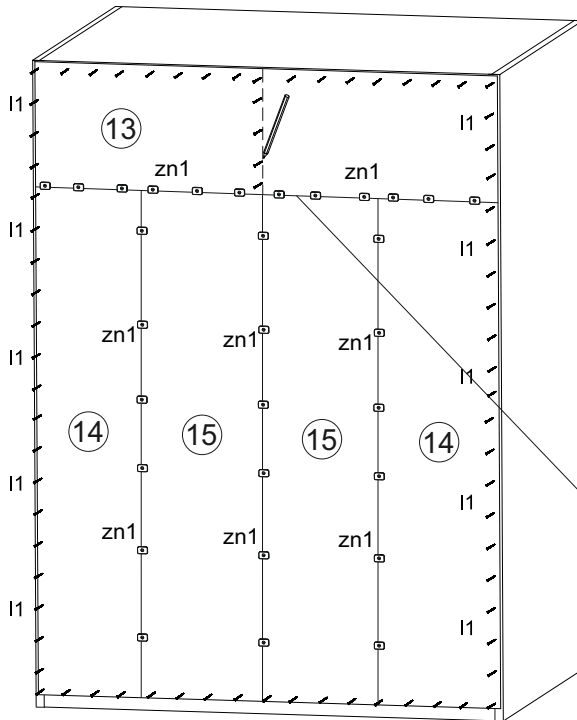
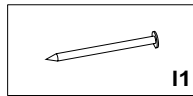
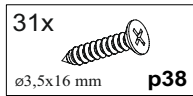

# 10

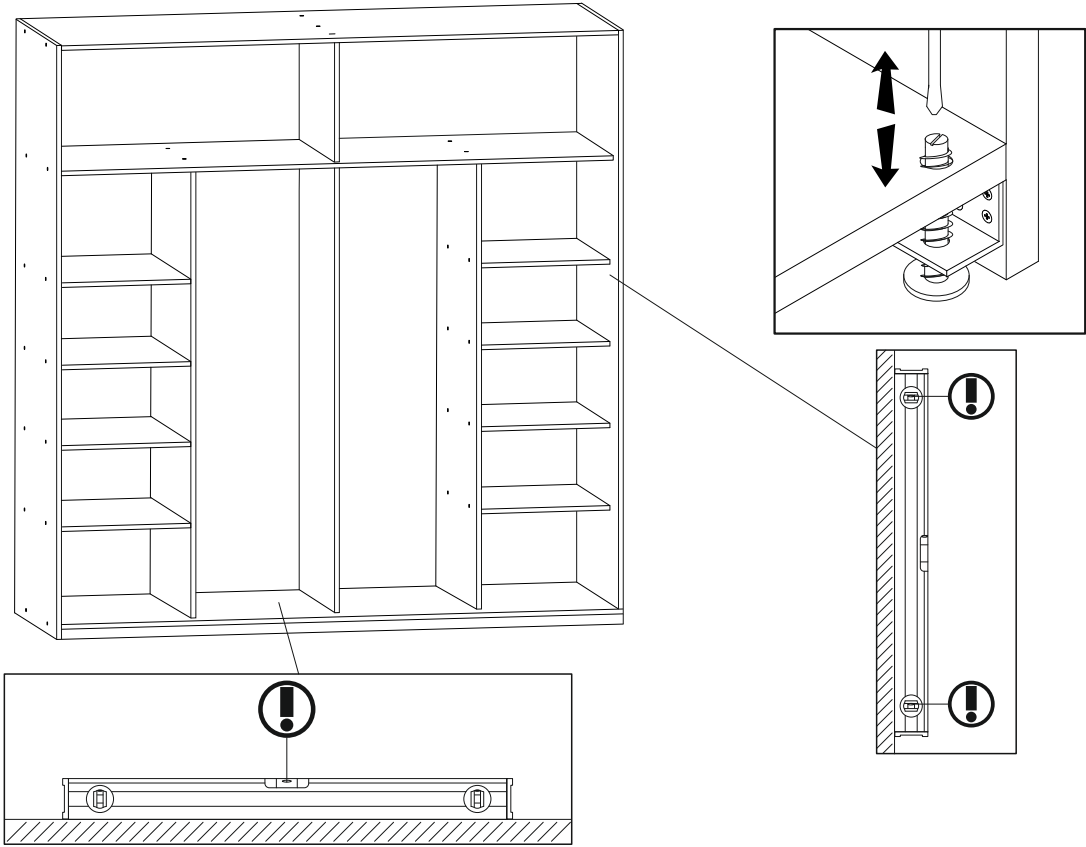

# 11

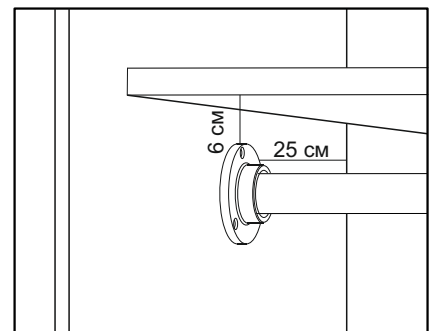
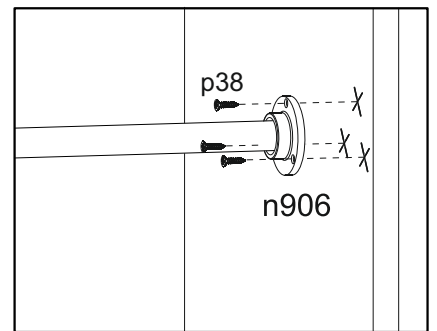
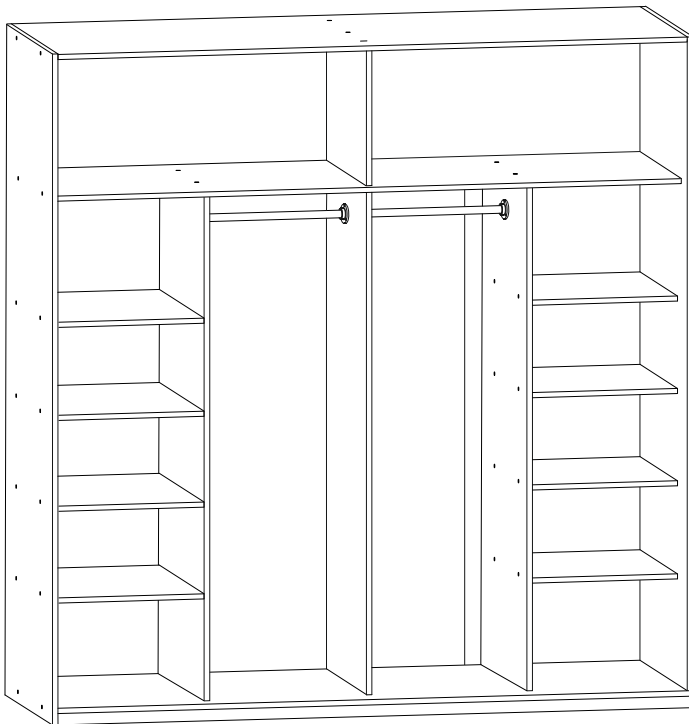
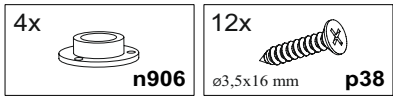

# 12

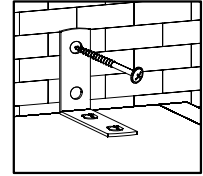
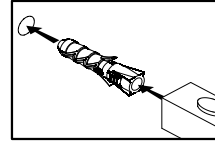
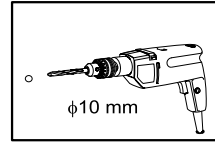
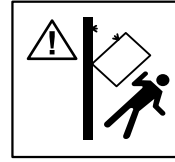
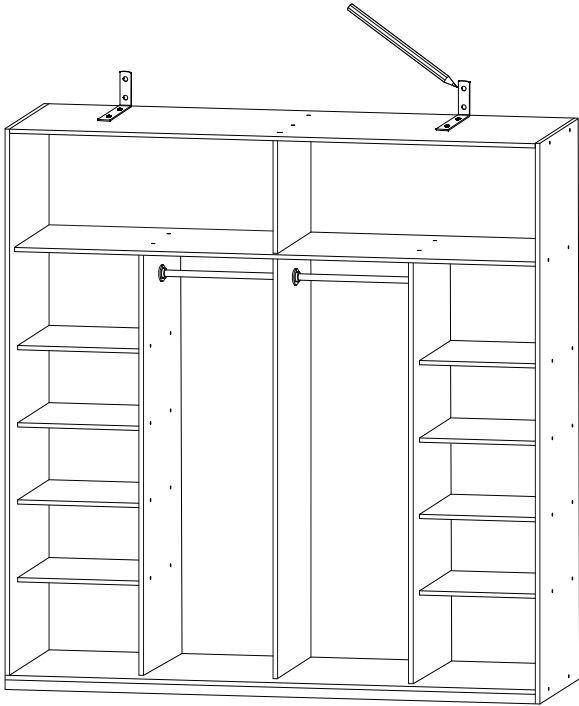

**ENG**

**UA**

The dowel and the wall mounting angle are not included. Purchase separately.

Дюбель та куток кріплення до стіни в комплект не входять. Необхідно придбати окремо.

# 13

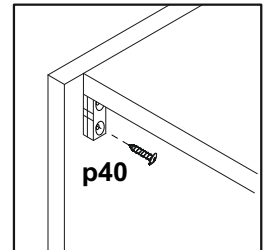
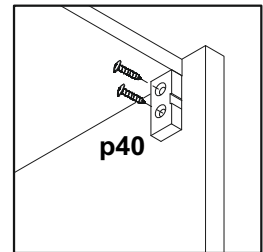
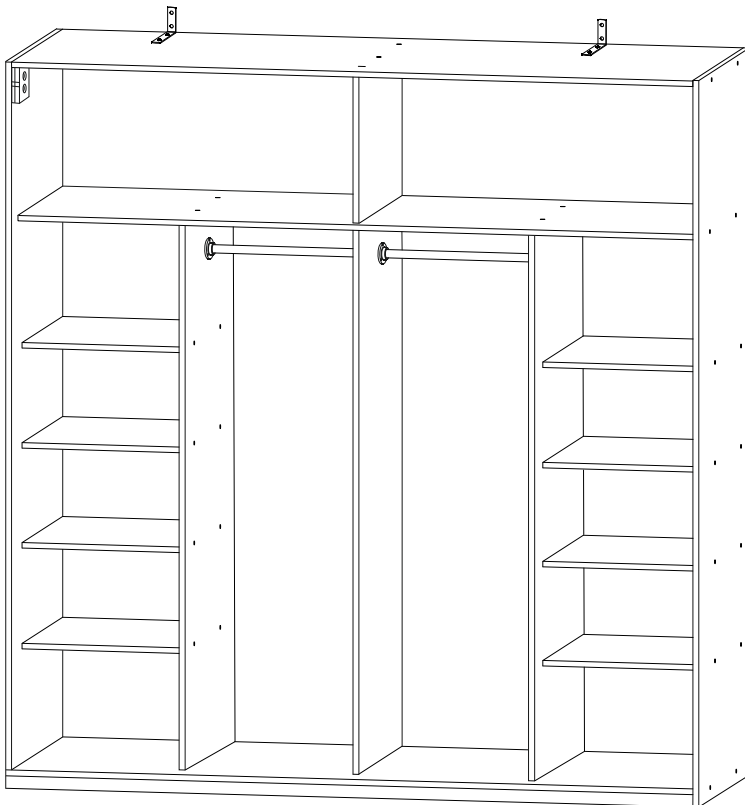
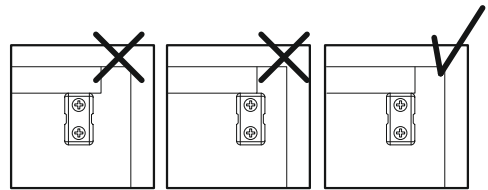
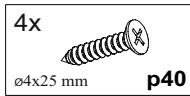

# 14

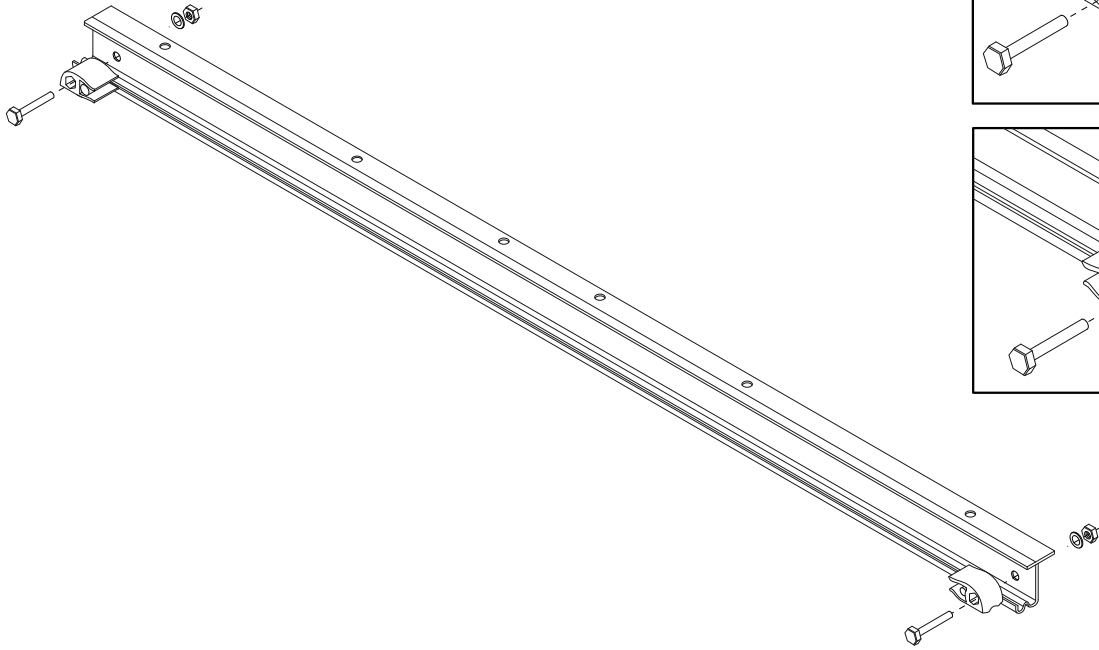

# 15

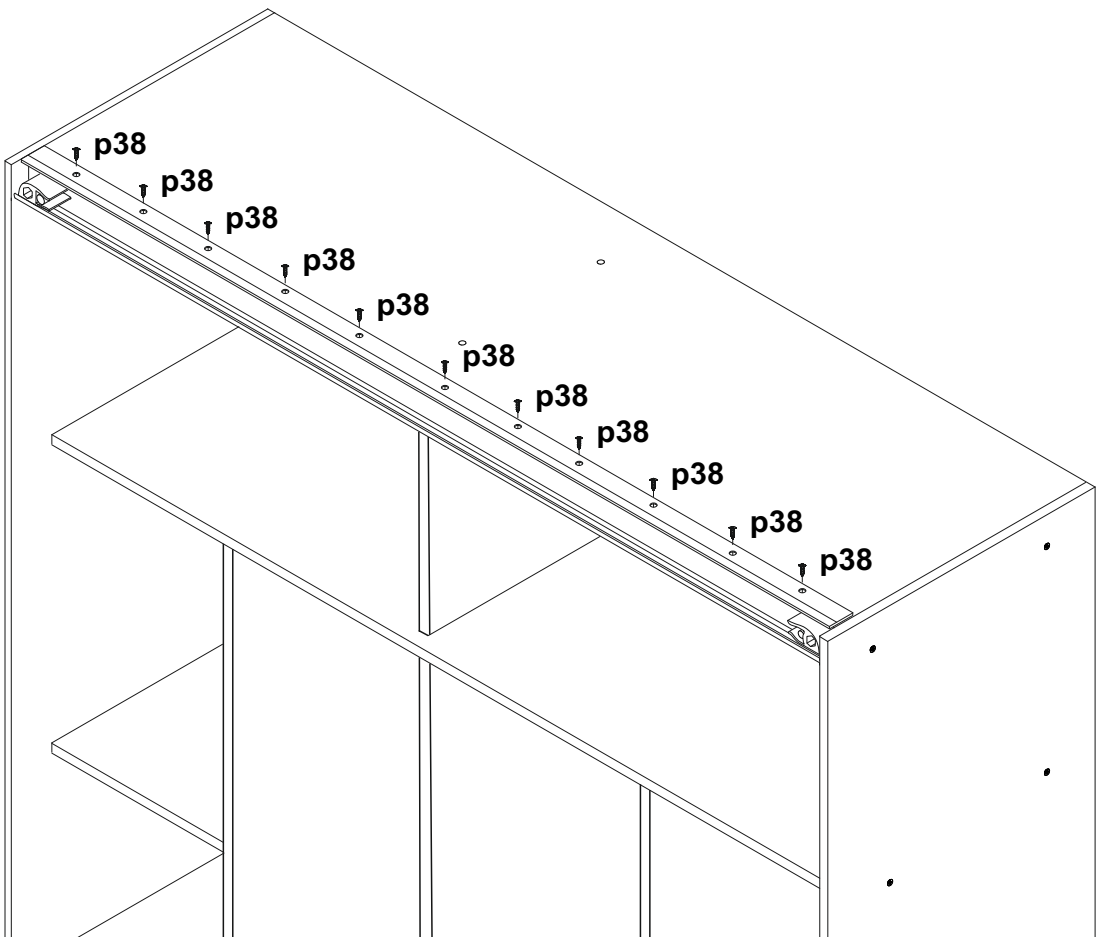
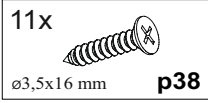

# 16

9x  
ø3,5x16 mm p38

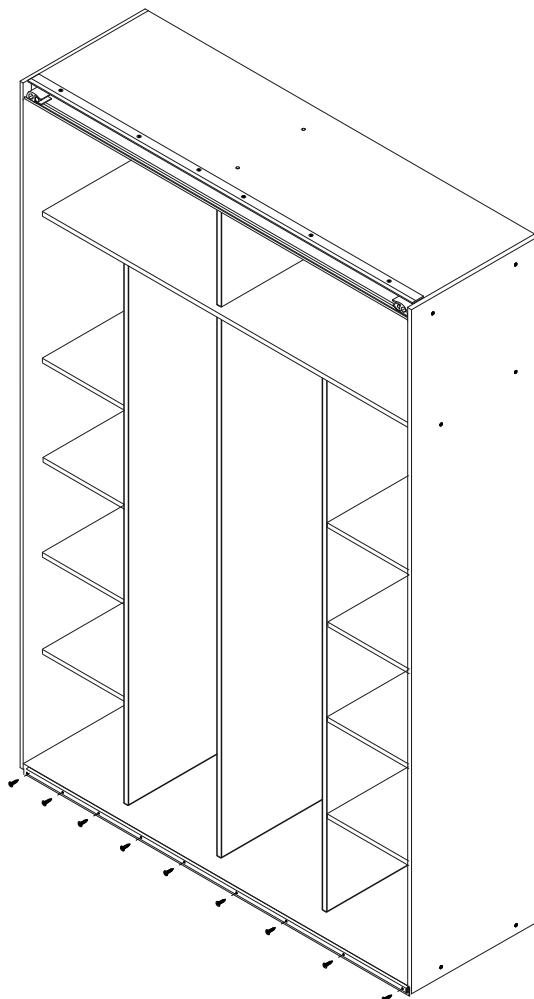
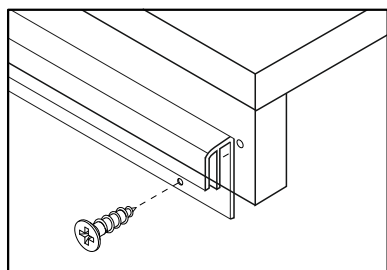
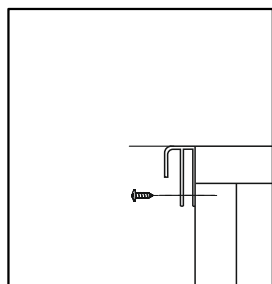

# 17

## 2x

12/18/24x  
ø8x60 mm f6

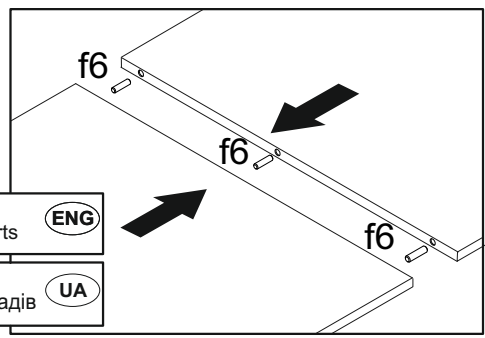
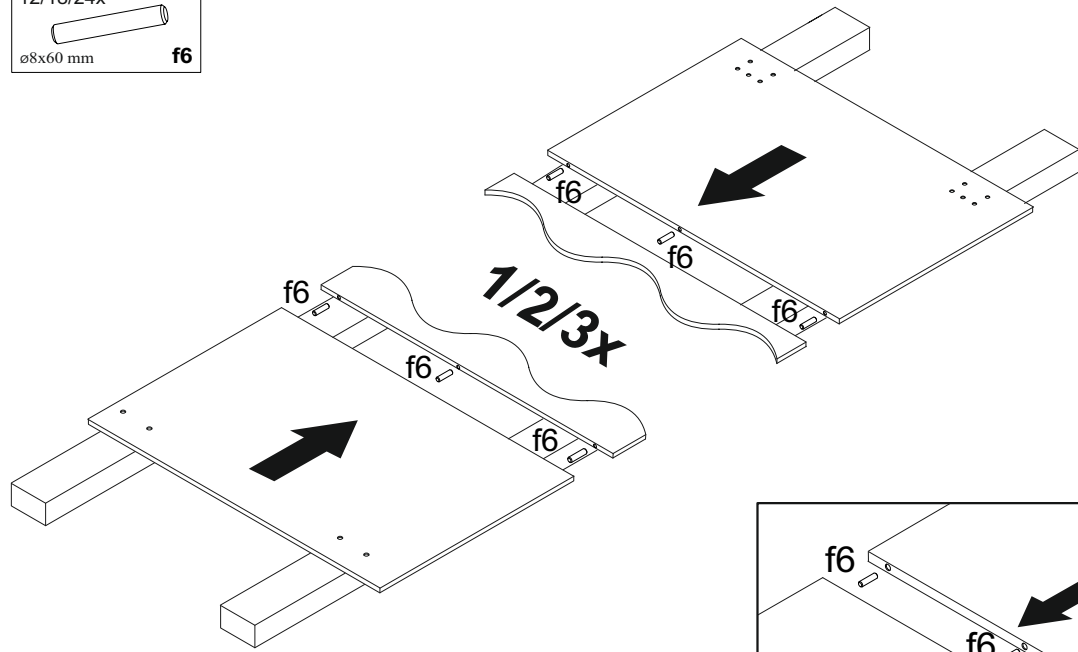
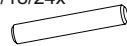

⚠ Depending model type  
on the every joint of facades parts **ENG**

⚠ Залежно від моделі  
на кожному стику частин фасадів **UA**

**18**  
**2x**

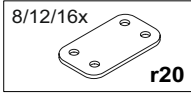

(ENG) Left facade  
(UA) Фасад лівий

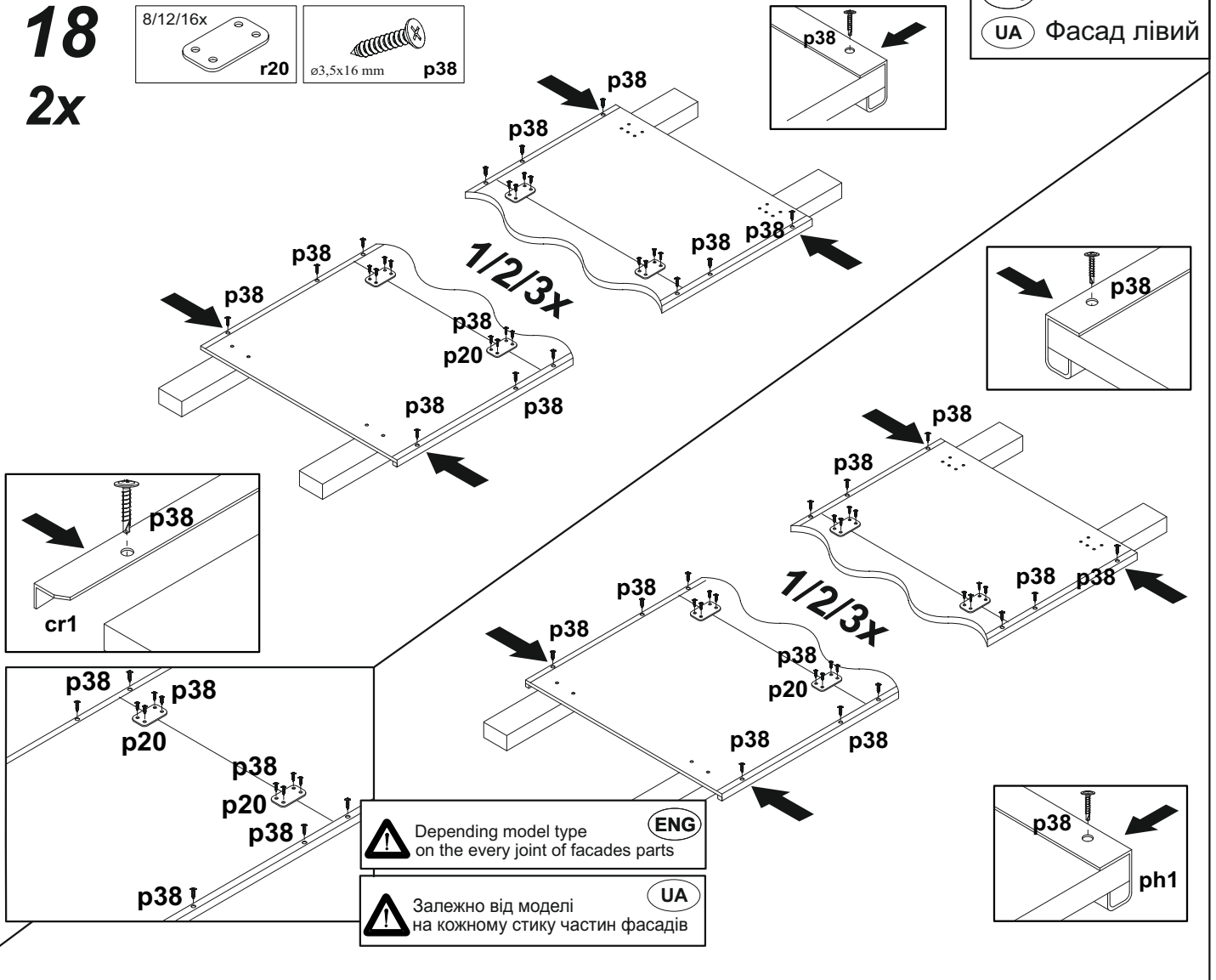

**19**

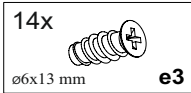

(ENG) Left facade  
(UA) Фасад лівий

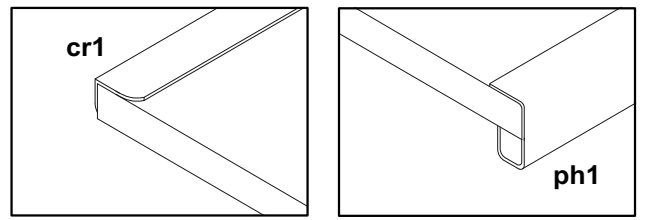
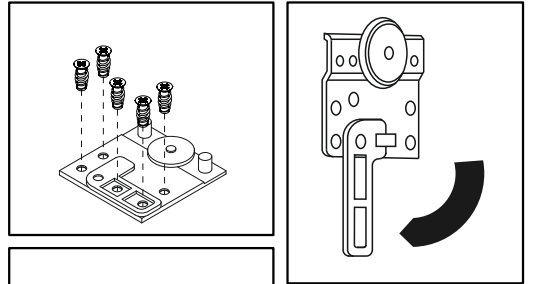

# 20

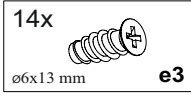

**ENG** Right facade  
**UA** Фасад правий

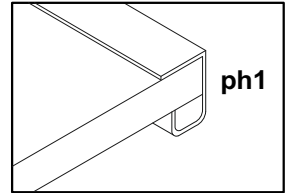
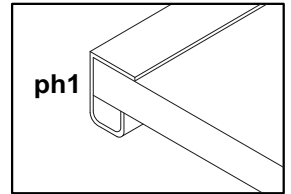
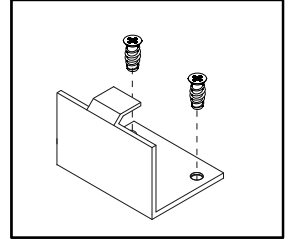
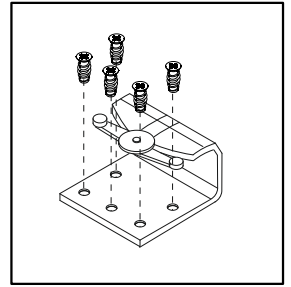
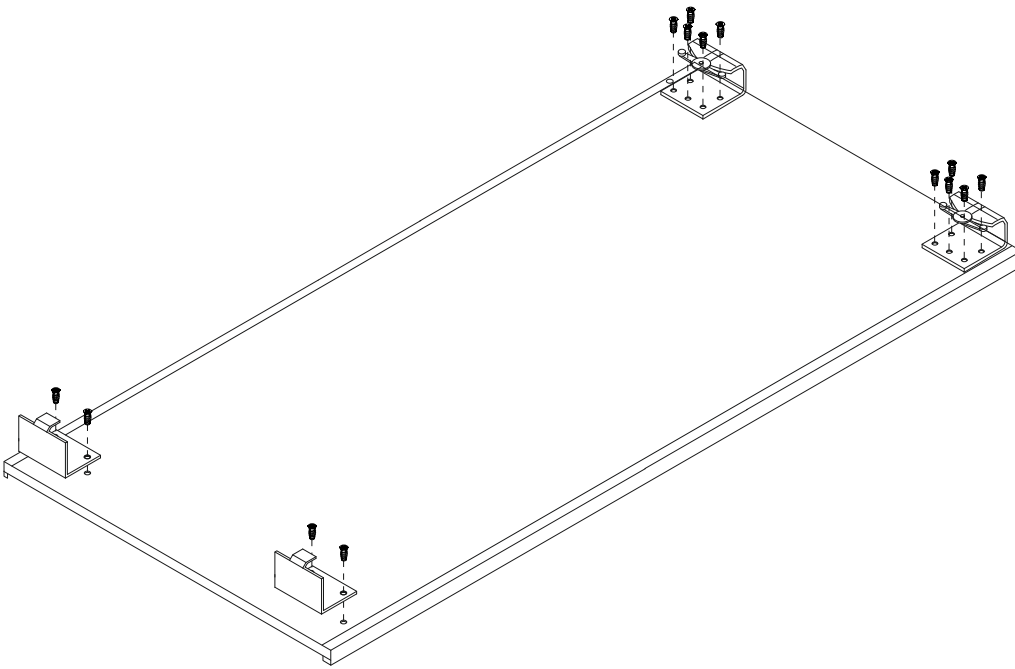

# 21

**ENG** Left facade  
**UA** Фасад лівий

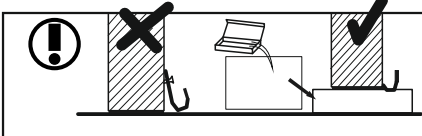
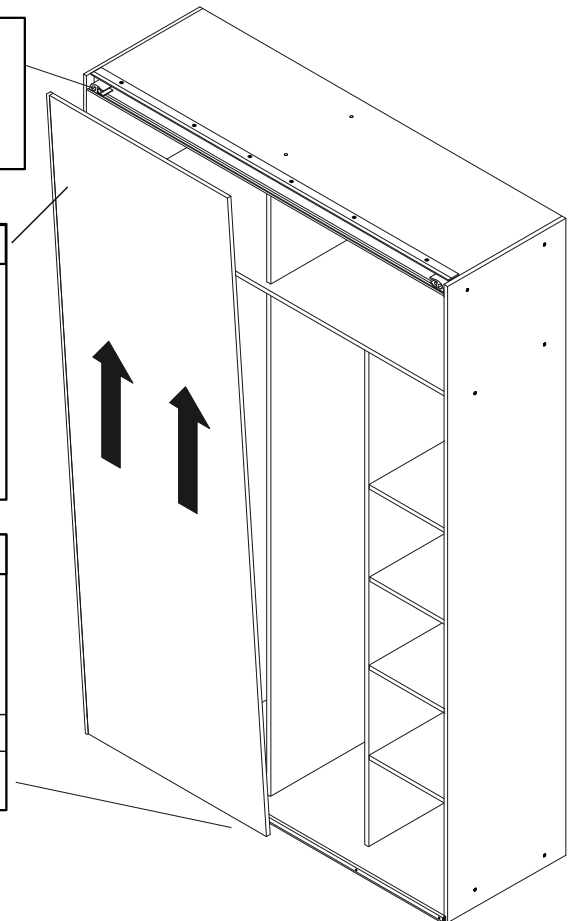
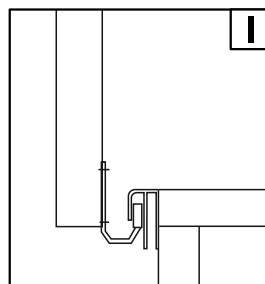
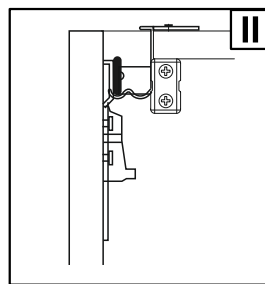
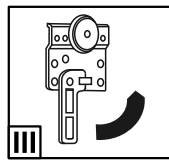

# 22

ENG Right facade  
UA Фасад правий

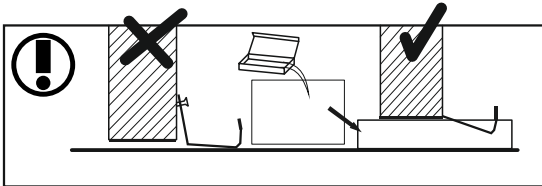
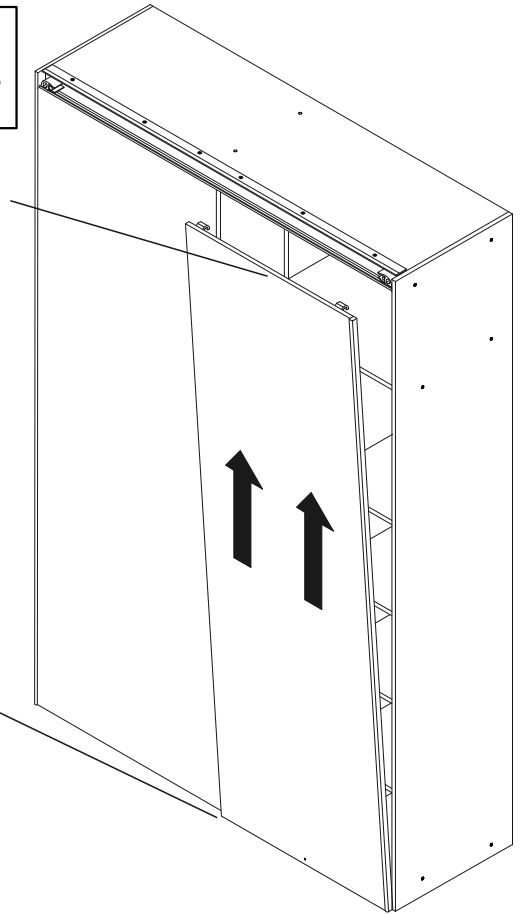
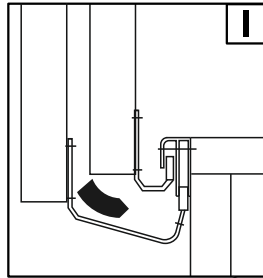
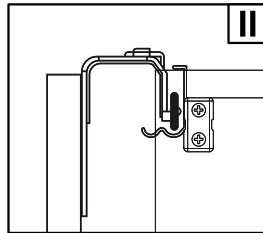
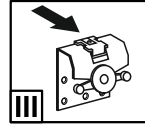

# 23

